



Installation Guide

EV Charging Single Phase Inverter

with SetApp Configuration

For Europe, APAC and South Africa

Version 1.1

Disclaimers

Important Notice

Copyright © SolarEdge Inc. All rights reserved.

No part of this document may be reproduced, stored in a retrieval system or transmitted, in any form or by any means, electronic, mechanical, photographic, magnetic or otherwise, without the prior written permission of SolarEdge Inc.

The material furnished in this document is believed to be accurate and reliable. However, SolarEdge assumes no responsibility for the use of this material. SolarEdge reserves the right to make changes to the material at any time and without notice. You may refer to the SolarEdge web site (www.solaredge.com) for the most updated version.

All company and brand products and service names are trademarks or registered trademarks of their respective holders.

Patent marking notice: see <http://www.solaredge.com/patent>

The general terms and conditions of delivery of SolarEdge shall apply.



The content of these documents is continually reviewed and amended, where necessary. However, discrepancies cannot be excluded. No guarantee is made for the completeness of these documents.



The images contained in this document are for illustrative purposes only and may vary depending on product models.

Emission Compliance

This equipment has been tested and found to comply with the limits applied by the local regulations.

These limits are designed to provide reasonable protection against harmful interference in a residential installation. This equipment generates, uses and can radiate radio frequency energy and, if not installed and used in accordance with the instructions, may cause harmful interference to radio communications. However, there is no guarantee that interference will not occur in a particular installation. If this equipment does cause harmful interference to radio or television reception, which can be determined by turning the equipment off and on, you are encouraged to try to correct the interference by one or more of the following measures:

-  Reorient or relocate the receiving antenna.
-  Increase the separation between the equipment and the receiver.

-  Connect the equipment into an outlet on a circuit different from that to which the receiver is connected.
-  Consult the dealer or an experienced radio/TV technician for help.

Changes or modifications not expressly approved by the party responsible for compliance may void the user's authority to operate the equipment.



Support and Contact Information



If you have technical problems concerning SolarEdge products, please contact us:

Support Center: <https://www.solaredge.com/service/support>



Country	Phone	E-Mail
Australia (+61)	1800 465 567	support@solaredge.net.au
APAC (Asia Pacific)(+972)	073 240 3118	support-asia@solaredge.com
Belgium (+32)	0800-76633	support@solaredge.be
China (+86)	21 6212 5536	support_china@solaredge.com
DACH & Rest of Europe (+49)	089 45459730	support@solaredge.de
France (+33)	0806 700409	support@solaredge.fr
Italy (+39)	0422 053700	support@solaredge.it
Japan (+81)	03 6262 1223	support@solaredge.jp
Netherlands (+31)	0800 7105	support@solaredge.nl
New Zealand (+64)	0800 144 875	support@solaredge.net.au
Republic of Ireland (+353)	1800 901 575	support-uk@solaredge.com
United Kingdom (+44)	0800 0281183	
US & Canada (+1)	510 498 3200	ussupport@solaredge.com
Greece (+49)	89 454 59730	support@solaredge.com
Israel (+972)	073 240 3122	
Middle East & Africa (+972)	073 240 3118	
South Africa (+27)	0800 982 659	
Turkey (+90)	216 706 1929	
Worldwide (+972)	073 240 3118	

Before contact, make sure to have the following information at hand:

-  Model and serial number of the product in question.
-  The error indicated on the Inverter SetApp mobile application or on the monitoring platform or by the LEDs, if there is such an indication.
-  System configuration information, including the type and number of modules connected and the number and length of strings.

-  The communication method to the SolarEdge server, if the site is connected.
-  The inverter software version as appears in the status screen.

Revision History

-  Version 1.1, May 2019 - editorial changes
-  Version 1.0, March 2019 - first release

Contents

Disclaimers	1
Important Notice	1
Emission Compliance	1
Support and Contact Information	3
HANDLING AND SAFETY INSTRUCTIONS	7
Safety Symbols Information	7
IMPORTANT SAFETY INSTRUCTIONS	8
Chapter 1: Introducing the SolarEdge Power Harvesting System	11
Power Optimizer	12
EV Charging Single Phase Inverter	12
Monitoring Platform	13
Installation Procedure	14
Installation Equipment List	14
Inverter Transport and Storage	15
EV Charging Safety Instructions	16
Chapter 2: Installing the Power Optimizers	17
Safety	17
Installation Guidelines	18
Step 1: Mounting the Power Optimizers	20
Step 3: Connecting Power Optimizers in Strings	21
Step 4: Verifying Proper Power Optimizer Connection	21
Chapter 3: Installing the Inverter	23
Inverter Package Contents	23
Identifying the Inverter	23
Inverter Interfaces	23
Mounting the Inverter	27
Chapter 4: Connecting the AC and the Strings to the Connection Unit	31
Selecting a Residual Current Device (RCD)	34
Chapter 5: Activating, Commissioning and Configuring the System	35
Step 1: Activating the Installation	35
Step 2: Commissioning and Configuring the Installation	36
Step 3: Verifying Proper Activation and Commissioning	40
Viewing System Status	41
Reporting and Monitoring Installation Data	48
Chapter 6: Setting Up Communication	51
Communication Options	51
Communication Connectors	53
Removing the Inverter Cover	54

Removing the Connection Unit Cover	54
Creating an Ethernet (LAN) Connection	55
Creating an RS485 Bus Connection	58
Verifying the Connection	59
Appendix A: Errors and Troubleshooting	61
Identifying Errors	61
EV Charger-related Troubleshooting	62
Power Optimizer Troubleshooting	65
Appendix B: Mechanical Specifications	67
Appendix C: Replacing and Adding System Components	68
Fuse Replacement	68
Replacing an Inverter	69
Replacing the Connection Unit	70
Appendix D: SafeDC™	73
Technical Specifications - EV Charging Single Phase Inverter (Europe & APAC) ..	74
Inverter Specifications	74
Default Trip Limits and Times According to IEEE1547	77
EV Charger and EV Charger Cable Specifications	78

HANDLING AND SAFETY INSTRUCTIONS

During installation, testing and inspection, adherence to all the handling and safety instructions is mandatory. **Failure to do so may result in injury or loss of life and damage to the equipment.**

Safety Symbols Information

The following safety symbols are used in this document. Familiarize yourself with the symbols and their meaning before installing or operating the system.

WARNING!



Denotes a hazard. It calls attention to a procedure that, if not correctly performed or adhered to, could result in **injury or loss of life**. Do not proceed beyond a warning note until the indicated conditions are fully understood and met.

CAUTION!



Denotes a hazard. It calls attention to a procedure that, if not correctly performed or adhered to, could result in **damage or destruction of the product**. Do not proceed beyond a caution sign until the indicated conditions are fully understood and met.



NOTE

Denotes additional information about the current subject.



IMPORTANT SAFETY FEATURE

Denotes information about safety issues.

Disposal requirements under the Waste Electrical and Electronic Equipment (WEEE) regulations:



NOTE

Discard this product according to local regulations or send it back to SolarEdge.

IMPORTANT SAFETY INSTRUCTIONS

SAVE THESE INSTRUCTIONS

WARNING!

When using electric products, basic precautions should always be followed, including the following. This manual contains important instructions that shall be followed during installation, operation and maintenance of the unit.

- a. Read all the instructions before using this product.
- b. This device should be supervised when used around children.
- c. Do not put fingers into the electric vehicle connector.
- d. Do not use this product if the flexible power cord or EV cable is frayed, has broken insulation, or any other signs of damage.



- e. Do not use this product if the enclosure or the EV connector is broken, cracked, open, or shows any other indication of damage.
 1. An insulated grounding conductor that is identical in size, insulation material, and thickness to the grounded and ungrounded branch-circuit supply conductors, except that it is green with or without one or more yellow stripes, shall be installed as part of the branch circuit that supplies the device or system.
 2. The grounding conductor described in item 1 shall be grounded to earth at the service equipment or, when supplied by a separately derived system, at the supply transformer.

WARNING!



The inverter cover must be opened only after switching the inverter ON/OFF/P switch located at the bottom of the inverter to OFF. This disables the DC voltage inside the inverter. Wait five minutes before opening the cover. Otherwise, there is a risk of electric shock from energy stored in the capacitors.

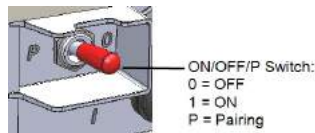

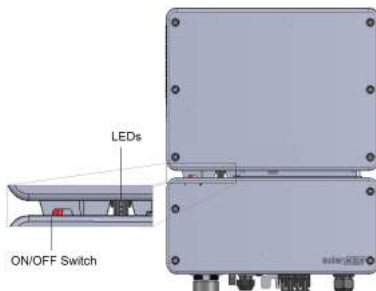
**WARNING!**

Before operating the inverter, ensure that the inverter AC power cable and wall outlet are grounded properly. This product must be connected to a grounded, metal, permanent wiring system, or an equipment-grounding conductor must be run with the circuit conductors and connected to the equipment grounding terminal or lead on the product.

WARNING!

Opening the inverter and repairing or testing under power must be performed only by qualified service personnel familiar with this inverter.

WARNING!

Do not touch the PV panels or any rail system connected when the inverter switch is ON, unless grounded.

WARNING!

SafeDC complies with IEC60947-3 when installing the system with a worst case SafeDC voltage (under fault conditions) < 120V.

The worst case voltage is defined as: $V_{oc,max} + (\text{String Length} - 1) * 1V$, where:

- $V_{oc,max}$ = Maximum V_{oc} (at lowest temperature) of the PV module in the string (for a string with multiple module models, use the max value)
- String Length = number of power optimizers in the string

CAUTION!

This unit must be operated according to the technical specification datasheet provided with the unit.

CAUTION!

HEAVY OBJECT. To avoid muscle strain or back injury, use proper lifting techniques, and if required - a lifting aid.

NOTE

Use PV modules rated according to IEC 61730 class A.

NOTE



The symbol  appears at grounding points on the SolarEdge equipment. This symbol is also used in this manual.

NOTE

A SolarEdge inverter may be installed in a site with a generator, however must not operate at the same time as the generator.

Operating an inverter and a generator simultaneously will void the warranty.



SolarEdge requires installing a physical or electronic interlock, which will prevent the generator and inverter from operating simultaneously. Interlock procurement, installation, maintenance and support are the responsibility of the installer. Damage to the inverter due to incorrect interlock installation or use of an interlock that is incompatible with the SolarEdge system will render the SolarEdge warranty invalid.

NOTE

The following warning symbols appear on the inverter warning label:



Risk of electric shock



Risk of electric shock from energy stored in the capacitor. Do not remove cover until 5 minutes after disconnecting all sources of supply.



Hot surface – To reduce the risk of burns, do not touch.

Chapter 1: Introducing the SolarEdge Power Harvesting System

The SolarEdge power harvesting solution maximizes the power output from any type of solar Photovoltaic (PV) installation while reducing the average cost per watt. The following sections describe each of the system's components.

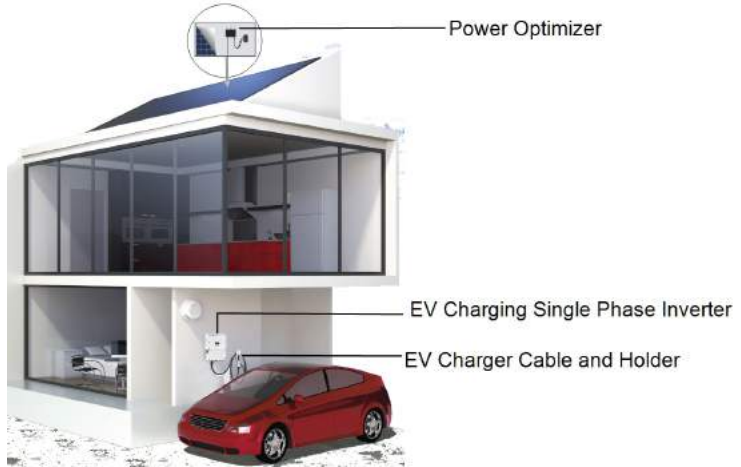

Figure 1: The SolarEdge power harvesting system components

Power Optimizer

The power optimizers are DC-DC converters connected to PV modules in order to maximize power harvesting by performing independent Maximum Power Point Tracking (MPPT) at the module level.

The power optimizers regulate the string voltage at a constant level, regardless of string length and environmental conditions.

The power optimizers include a safety voltage function that automatically reduces the output of each power optimizer to 1 Vdc in the following cases:

- During fault conditions
- The power optimizers are disconnected from the inverter
- The inverter ON/OFF/P switch is turned OFF
- The safety switch on the Connection Unit is turned OFF
- The inverter AC breaker is turned OFF

Each power optimizer also transmits module performance data over the DC power line to the inverter.

Two types of power optimizers are available:

- Module Add-on power optimizer – connected to one or more modules
- Smart modules - the power optimizer is embedded into a module

EV Charging Single Phase Inverter

The EV Charging Single Phase Inverter (referred to as “inverter” throughout) efficiently converts DC power from the modules into AC power that can be fed into the main AC service of the site and from there to the grid. The inverter also receives the monitoring data from each power optimizer and transmits it to a central server (the monitoring platform; requires Internet connection).

The EV Charging Single Phase Inverter is designed to provide reliable and economical charging of an electric vehicle (EV). It provides Level 2 EV charging from both the grid and the PV system, and is designed to work with all plug-in vehicles with J1772 (Type 1) socket.

An EV Charger cable (ordered separately) is required for EV charging:

- The EV Charger Cable connects the EV plug to the inverter
- The wall mounted EV Charger cable holder is used for hanging the EV Charger cable and plug, protecting the plug from rain when not plugged into the vehicle (V2 holders), and provides strain relief for the inverter when the cable is pulled.

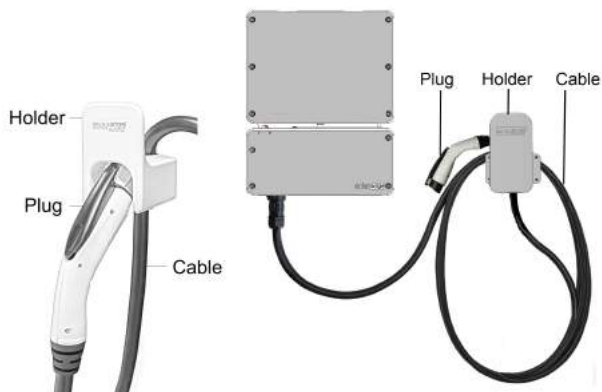

Figure 2: The EV Charger Cables (with holders)

Monitoring Platform

The monitoring platform enables monitoring the technical and financial performance of one or more SolarEdge sites. It provides past and present information on the system performance both at the system and module levels.

Installation Procedure



The following is the procedure for installing and setting up a new SolarEdge site. Many of these also apply to modification of an existing site.

1. [Connecting Power Optimizers in Strings](#), page 21.
2. [Recording power optimizer serial numbers \(optional\)](#), page 49.
3. [Mounting the inverter](#), page 27.
4. [Connecting the AC and the Strings to the Connection Unit](#), page 31.
5. [Activating, Commissioning and Configuring the System Using the Inverter SetApp](#), page 35
6. [Connecting the inverter to the monitoring platform](#), page 50.
7. Installing and connecting the cable - Refer to the installation guide supplied with the product. The cable and holder can be installed at the same time as the inverter or added later.
8. Configuring the EV Charger - Refer to the installation guide supplied with the EV Charger Cable. Configuration can be done only after the EV Charger Cable is connected to the inverter and the inverter is connected to the monitoring platform.







Installation Equipment List

Standard tools can be used during the installation of the SolarEdge system. The following is a recommendation of the equipment needed for installation:

- Allen screwdriver for 3mm screw type for the inverter cover, side screws, and Connection Unit cover (if applicable)
- Standard flat-head screwdrivers set
- Non-contact voltage detector
- Cordless drill (with a torque clutch) or screwdriver and bits suitable for the surface on which the inverter and optimizers will be installed. Use of an impact driver is *not* allowed.
- Appropriate mounting hardware (for example: stainless bolts, nuts, and washers) for attaching:
 - the inverter mounting bracket to the mounting surface
 - the power optimizer to the racking (not required for smart modules)
- MC4 crimper
- Wire cutters

-  Wire strippers
-  Voltmeter
-  Mobile phone with latest SetApp version

For installing the communication options, you may also need the following:

-  For Ethernet:
 -  CAT5/6 twisted pair Ethernet cable with RJ45 connector
 -  If using a CAT5/6 cable spool: RJ45 plug and RJ45 crimper
-  For RS485:
 -  Four- or six-wire shielded twisted pair cable
 -  Watchmaker precision screwdriver set

Inverter Transport and Storage

Transport the inverter in its original packaging, facing up and without exposing it to unnecessary shocks. If the original package is no longer available, use a similar box that can withstand the weight of the inverter (refer to the inverter weight in the specification datasheet provided with the unit), has a handle system and can be closed fully.

Store the inverter in a dry place where ambient temperatures are -25°C to +65°C / -13°F to 149°F.

EV Charging Safety Instructions



WARNING!

Do not charge a vehicle indoors if it requires ventilation. Contact your EV service representative for information.



WARNING!

Automatic CCID (charge circuit interrupting device) reset provided.



WARNING!

Risk of electric shock. Do not remove cover. No user serviceable parts inside. Refer servicing to qualified service personnel.



CAUTION!

Do not use this product if there is any damage to the unit.



CAUTION!

Do not use an extension cord between the SolarEdge EV Charger Cable and the inverter. You may use a conversion adapter only if it has been approved by SolarEdge.



NOTE

This product is intended for use with electric vehicles, however it operates as a PV inverter also when no charging cable is connected.

Chapter 2: Installing the Power Optimizers

Safety

The following notes and warnings apply when installing the power optimizers. Some of the following may not be applicable to smart modules:

WARNING!



When modifying an existing installation, turn OFF the inverter ON/OFF/P switch, the Safety Switch (if applicable) and the AC circuit breaker on the main AC distribution panel.

CAUTION!



Power optimizers are IP68/NEMA6P rated. Choose a mounting location where optimizers will not be submerged in water.

CAUTION!



This unit must be operated according to the operating specifications provided with the unit.

CAUTION!



Cutting the power optimizer input or output cable connector is prohibited and will void the warranty.

CAUTION!



All PV modules must be connected to a power optimizer.

CAUTION!



If you intend to mount the optimizers directly to the module or module frame, first consult the module manufacturer for guidance regarding the mounting location and the impact, if any, on module warranty. Drilling holes in the module frame should be done according to the module manufacturer instructions.

CAUTION!

Installing a SolarEdge system without ensuring compatibility of the module connectors with the optimizer connectors may be unsafe and could cause functionality problems such as ground faults, resulting in inverter shut down. To ensure mechanical compatibility of the power optimizers' connectors with the PV modules' connectors to which they are connected:

- Use identical connectors from the same manufacturer and of the same type on both the power optimizers and on the modules; or
- Verify that the connectors are compatible in the following way:
 - The module connector manufacturer should explicitly verify compatibility with the SolarEdge optimizer connector; and
 - A third-party test report by one of the listed external labs (TUV, VDE, Bureau Veritas UL, CSA, InterTek) should be obtained, verifying the compatibility of the connectors.



For more information, refer to

<https://www.solaredge.com/sites/default/files/optimizer-input-connector-compatibility.pdf>

**IMPORTANT SAFETY FEATURE**

Modules with SolarEdge power optimizers are safe. They carry only a low safety voltage before the inverter is turned ON. As long as the power optimizers are not connected to the inverter or the inverter is turned OFF, each power optimizer will output a safe voltage of 1V.

Installation Guidelines

- The minimum and maximum string length guidelines are stated in the power optimizer datasheets. Refer to the Designer for string length verification. The Designer is available on the SolarEdge website at <https://www.solaredge.com/products/installer-tools/designer#/>.
- Frame-mounted power optimizers are mounted directly on the module frame, regardless of racking system (rail-less or with rails). For installation of frame-mounted power optimizers, refer to http://www.solaredge.com/sites/default/files/installing_frame_mounted_power_optimizers.pdf.
- The power optimizer can be placed in any orientation.



- If connecting more modules than optimizer inputs in parallel, use a branch cable. Some commercial power optimizer models have a dual input.
- Position the power optimizer close enough to its module so that their cables can be connected.
- Make sure to use power optimizers that have the required output conductor length:
 - *Do not* use extension cables between a module and a power optimizer, between two modules connected to the same optimizer, or between two optimizers other than in the cases specified below.
 - You can use extension cables between power optimizers only from row to row, around obstacles within a row, and from the end of the string to the inverter, as long as the maximum distance is not exceeded.

NOTE

- Use at least 11 AWG/ 4 mm² DC cables.
- The total cable length of the string (excluding power optimizers' cables) should not exceed 1000ft./300 m from DC+ to DC- of the inverter.

- Completely shaded modules may cause their power optimizers to temporarily shut down. This will not affect the performance of the other power optimizers in the string, as long as the minimum number of unshaded power optimizers connected in a string of modules is met. If under typical conditions fewer than the minimum optimizers are connected to unshaded modules, add more optimizers to the string.
- To allow for heat dissipation, maintain a minimum of 2.5 cm / 1" clearance between the power optimizer and other surfaces, on all sides except the mounting bracket side.

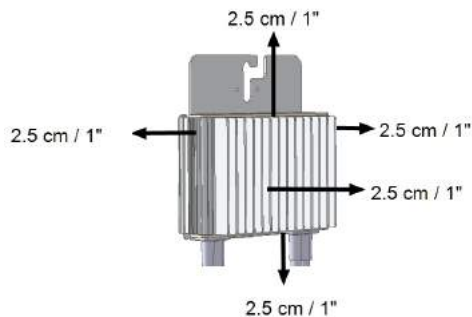

Figure 3: Power optimizer clearance

- When installing modules in a confined space, for example, if installing Building-integrated photovoltaic (BIPV) modules, ventilation measures may be needed to ensure the power optimizers are not be exposed to temperatures outside their specifications.

NOTE

The images contained herein are for illustrative purposes only and may vary depending on product models.

Step 1: Mounting the Power Optimizers

For each of the power optimizers⁽¹⁾:

1. Determine the power optimizer mounting location and use the power optimizer mounting brackets to attach the power optimizer to the support structure. It is recommended to mount the power optimizer in a location protected from direct sunlight. For frame-mounted power optimizers follow the instructions supplied with the optimizers, or refer to https://www.solaredge.com/sites/default/files/installing_frame_mounted_power_optimizers.pdf.
2. If required, mark the mounting hole locations and drill the hole.

**CAUTION!**

Drilling vibrations may damage the power optimizer and will void the warranty. Use a torque wrench or an electric drill with adjustable clutch that meets the mounting torque requirements. *Do not* use impact drivers for mounting the power optimizer.

Do not drill through the power optimizer or through the mounting holes.

3. Attach each power optimizer to the rack using M6 (1/4") stainless steel bolts, nuts and washers or other appropriate mounting hardware. Apply torque of 9-10 N*m / 6.5-7 lb*ft.
4. Verify that each power optimizer is securely attached to the module support structure.
5. Record power optimizer serial numbers and locations, as described in *Reporting and Monitoring Installation Data* on page 48.

(1)Not applicable to smart modules.

Step 3: Connecting Power Optimizers in Strings

You can construct parallel strings of unequal length, that is, the number of power optimizers in each string does not have to be the same. The minimum and maximum string lengths are specified in the power optimizer datasheets. Refer to the [Designer](#) for string length verification.



1. Connect the Minus (-) output connector of the string's first power optimizer to the Plus (+) output connector of the string's second power optimizer.
2. Connect the rest of the power optimizers in the string in the same manner.

WARNING!



If using a dual-input power optimizer and some inputs are not used, seal the unused input connectors with the supplied pair of seals.

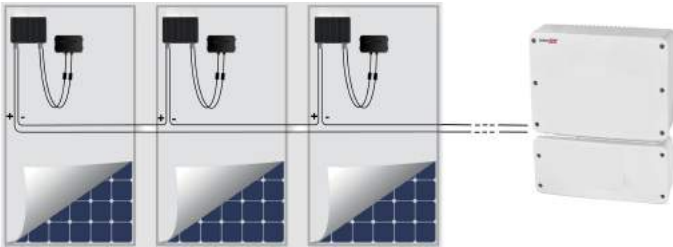

Figure 4: Power optimizers connected in series

3. If you intend to monitor the installation, using the monitoring platform, record the physical location of each power optimizer, as described in *Creating Logical and Physical Layout using Installation Information* on page 49.

Step 4: Verifying Proper Power Optimizer Connection

When a module is connected to a power optimizer, the power optimizer outputs a safe voltage of 1V ($\pm 0.1V$). Therefore, the total string voltage should equal 1V times the number of power optimizers connected in series in the string. For example, if 10 power optimizers are connected in a string, then 10V should be produced.

Make sure the PV modules are exposed to sunlight during this process. The power optimizer will only turn ON if the PV module provides at least 2W.

In SolarEdge systems, due to the introduction of power optimizers between the PV modules and the inverter, the short circuit current I_{SC} and the open circuit voltage V_{OC} hold different meanings from those in traditional systems.

For more information about the SolarEdge system's string voltage and current, refer to the V_{OC} and I_{SC} in *SolarEdge Systems Technical Note*, available on the SolarEdge website at:

https://www.solaredge.com/sites/default/files/isc_and_voc_in_solaredge_sytems_technical_note.pdf.



→ **To verify proper power optimizer connection:**

Measure the voltage of each string individually before connecting it to the other strings or to the inverter. Verify correct polarity by measuring the string polarity with a voltmeter. Use a voltmeter with at least 0.1V measurement accuracy.



NOTE

Since the inverter is not yet operating, you may measure the string voltage and verify correct polarity on the DC wires inside the Connection Unit.

For troubleshooting power optimizer operation problems, refer to *Power Optimizer Troubleshooting* on page 65.

Chapter 3: Installing the Inverter

Install the inverter either before or after the modules and power optimizers have been installed.



CAUTION!

Do not rest the connectors at the bottom of the inverter on the ground, as it may damage them. To rest the inverter on the ground, lay it on its back.

Inverter Package Contents

- One inverter with Connection Unit
- Mounting bracket kit
- Connection Unit sealing cover (if applicable, for use in case of inverter replacement)
- Installation guide
- Antenna and mounting bracket for wireless communication (in specific models)

Identifying the Inverter

Refer to the sticker on the inverter that specifies its **Serial Number** and its **Electrical Ratings**. Provide the serial number when contacting SolarEdge support. The serial number is also required when opening a new site in the monitoring platform.

Inverter Interfaces

The following figures show the inverter and Connection Unit connectors and interfaces.

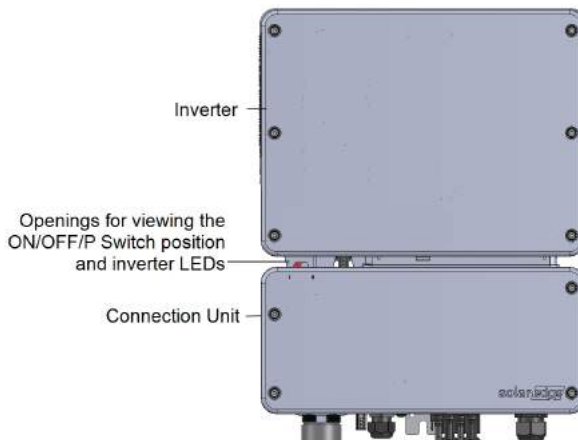

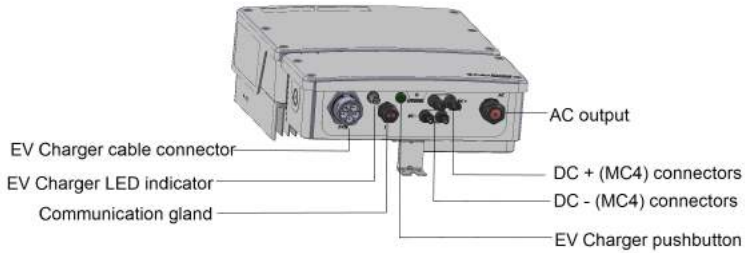

Figure 5: Inverter and Connection Unit interfaces

Connection Unit Interface

- EV Charger cable connector:** Used for connecting the EV charger cable to the inverter
- EV Charger LED indicator:** Three LEDs indicate the EV Charger statuses.

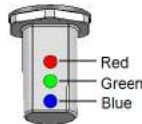

Figure 6: LEDs

The following table lists the LED indications when the EV Charger Cable is connected to the inverter and activated (refer to the EV Charger Cable Installation Guide supplied with the EV Charger Cable):

Color	Description
All LEDs	OFF - No AC power
Red	ON - Error
Blue	ON - the EV Charger is communicating with the inverter OFF - the EV Charger is not communicating with the inverter
Green	ON - Charging Blinking ⁽¹⁾ - the EV Charger is plugged in but not charging Flickering ⁽²⁾ - the EV Charger is ready to charge but not plugged in

(1)Lights ON for 1000mS and OFF for 1000mS

(2)Lights ON for 100mS and OFF for 5000mS

- **AC output / input** : For connection of the AC grid
- **DC input (MC4 connectors)**: For connection of the PV installation
- **Communication gland**: For connection of inverter communication options. Refer to *Setting Up Communication* on page 51 for more information.
- **EV Charger pushbutton**: Pressing the button on the Connection Unit has the following functionality:
 - For a system with scheduled charging: Start charging immediately (not during charging scheduled times). For setting a charging schedule, refer to the EV Charger Cable Installation Guide (supplied with the EV Charger Cable).
 - In case of an error ,the system re-tests after 15 minutes. Pressing the pushbutton performs the re-test immediately.

Inverter Interface

- **ON/OFF/P switch**: Turning this switch ON starts the operation of the power optimizers, enables power production and allows the inverter to begin exporting power to the utility grid. Turning it OFF reduces the power optimizer voltage to a low safety voltage and inhibits exportation of power. When this switch is OFF, the inverter control circuitry remains powered up.
- **Inverter LED indicator** (See *Figure 6*) : Indicate the inverter statuses as described in the following table:

Color	Description	Functionality
All LEDs turn on while the inverter is being configured.		
Green	Power production	<p>On - The inverter is producing power.</p> <p>Blinking - Standby mode. The inverter is in Standby mode until its working voltage is reached. The inverter then enters Production mode and produces power.</p> <p>Off - The inverter is not producing power. This may be during Night mode, when the inverter ON/OFF/P switch is OFF or when an error occurs.</p>

Color	Description	Functionality
Blue	Communication and inverter shutdown	Blinking: - Monitoring information is being received from a power optimizer. -The inverter is being shut down.
Red	Error	On - There is an error. Refer to <i>Errors and Troubleshooting</i> on page 61 for more information. Blinking - The inverter is being shut down.

DIP Switches

Set the circuit breaker rating DIP switches (see *Figure 7*).

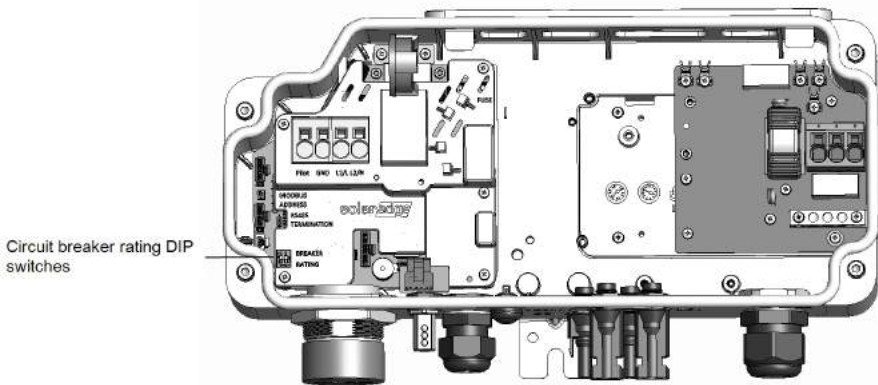

Figure 7: Connection Unit with EV Charger internal interfaces

→ To set the circuit breaker ratings:

Use the circuit breaker rating DIP switches to set circuit breaker ratings.

Circuit Breaker Rating	DIP Switch Settings		Maximum Allowed AC Current from Grid
	1 (left)	2 (right)	
20 A	OFF	OFF	16 A
25 A	ON	OFF	20 A
32 A	OFF	ON	25A
40 A	ON	ON	32 A

Buzzer

The EV charger includes a buzzer with the following indications:

Event	Buzzer Indication
Connected to EV	1 short beep
Charging starts	2 short beeps + 1 long beep
Error	5 beeps

Mounting the Inverter

The inverter is supplied with a mounting bracket kit:

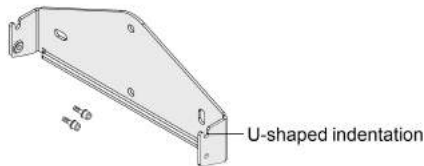

Figure 8: Mounting bracket

NOTE



Make sure the mounting surface or structure can support the weight of the inverter.

CAUTION!



SolarEdge inverters and power optimizers can be installed at a minimum distance of 50 m/ 164 ft from the shoreline of an ocean or other saline environment, as long as there are no direct salt water splashes on the inverter or power optimizer.

1. Determine the inverter mounting location, on a wall, stud framing or pole. It is recommended to mount the inverter in a location protected from direct sunlight.
2. To allow proper heat dissipation, maintain the following minimum clearance areas between the inverter and other objects:

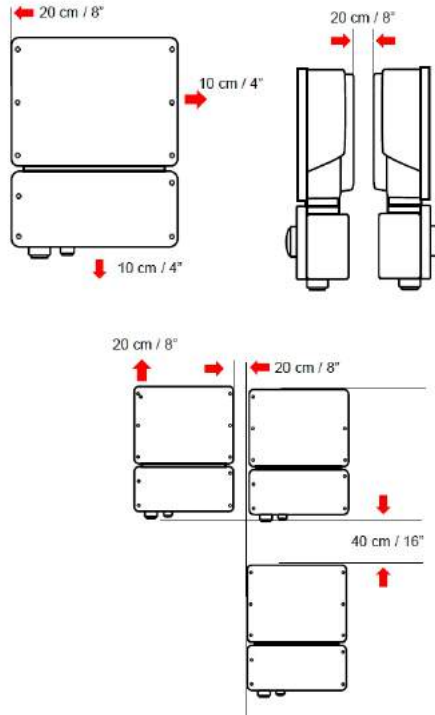

Figure 9: Clearance areas

- 20 cm (8") from the top of the inverter.
 - At least 18" (45 cm) from the bottom of the inverter if installing it indoors, 24" (60 cm) if outdoors; if conduit entry to the Connection Unit will be from the bottom, leave sufficient clearance for the conduits as well.
 - 10 cm (4") from the right and left of the inverter.
3. Position the mounting bracket against the wall/ pole and mark the drilling hole locations (refer to *Mechanical Specifications* on page 67 for inverter and mounting bracket dimensions).
 4. Drill the holes and mount the bracket. Verify that the bracket is firmly attached to the mounting surface.
 5. Hang the inverter on the bracket:

- a. Lift the inverter from the sides, or hold it at the top and bottom of the inverter to lift the unit into place.
- b. Lower the inverter onto the U-shaped indentations, as shown below. Let the inverter lay flat against the wall or pole.
- c. Insert the two supplied screws through the outer heat sink fin on both sides of the inverter and into the bracket. Tighten the screws with a torque of 4.0 N*m / 2.9 lb.*ft.

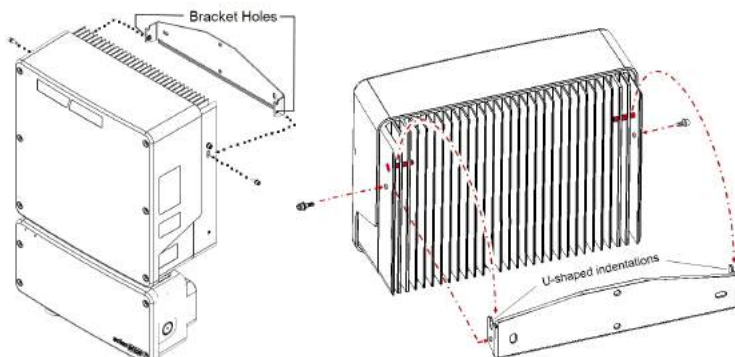

Figure 10: Hanging the inverter on the brackets

6. Optionally, secure the Connection Unit bracket to the wall/pole, using 3 screws:



NOTE

In case of inverter replacement with the Connection Unit still mounted, it is recommended to use all 3 holes.

- a. Mark the location of the bracket screw for the Connection Unit, and optionally the two additional bracket holes.

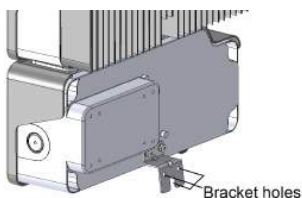

Figure 11: Connection Unit bracket

- b. Remove the inverter from the wall/ pole.
- c. Drill the hole for the Connection Unit bracket.

- d. Hang the inverter on the mounted brackets.
 - e. Fasten the Connection Unit bracket using a standard bolt.
7. Insert the screws at the top of the inverter brackets and fasten the brackets together.
 8. Verify that all the brackets are firmly attached to the mounting surface.

Chapter 4: Connecting the AC and the Strings to the Connection Unit

This chapter describes how to:

- Connect the Connection Unit to the AC grid, and to the PV strings.
- If required connect additional grounding, for example for installations in locations requiring earth rod.

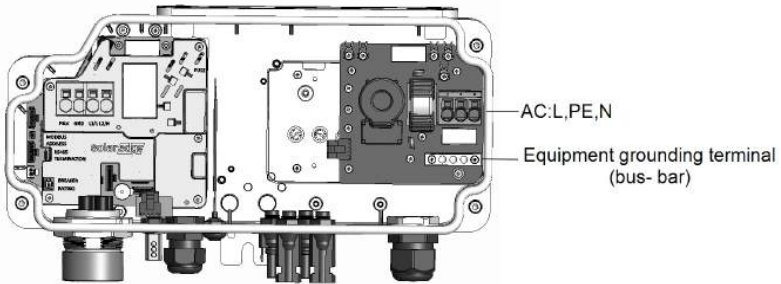

Figure 12: Inside the Connection Unit

➔ **To connect the AC grid and grounding to the Connection Unit:**

1. Turn OFF the AC circuit breaker.
2. Open the Connection Unit cover: Release the four Allen screws and carefully move the cover horizontally before lowering it.

CAUTION!



When removing the cover, make sure not to damage internal components. SolarEdge will not be held responsible for any components damaged as a result of incautious cover removal.

3. Strip the required length of the external and internal cables insulation.



Figure 13: Insulation stripping – AC

- Open the AC cable gland and insert the cable through the AC gland.

WARNING!

Turn OFF the AC before connecting the AC terminals. If connecting equipment grounding wire, connect it before connecting the AC Line and Neutral wires.

- Connect the AC wires according to the labels on the terminal block.

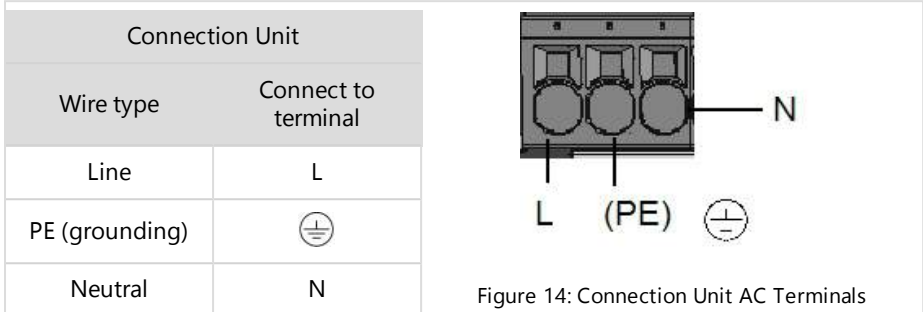

Figure 14: Connection Unit AC Terminals

- Check that the wires are fully inserted and cannot be pulled out easily.
- Tighten the AC cable gland with a torque of 2.8-3.3 N*m
- Verify that there are no unconnected wires to the inverter and that the unused terminal screws are tightened.

→ **To connect additional grounding:**

- Repeat steps 1- 3 from the previous procedure.
- Open the AC cable gland and insert the grounding cable through the AC gland.
- Strip 8mm of the grounding wire insulation (see Figure 13).
- Insert the grounding cable to the equipment grounding bus-bar (see Figure 12).
- Tighten the bus-bar screw with a torque of: 3.4 N*M

→ To connect the strings to the Connection Unit with MC4 connectors:

Connect the DC connectors of each string to the DC+ and DC- connectors according to the labels on the Connection Unit.

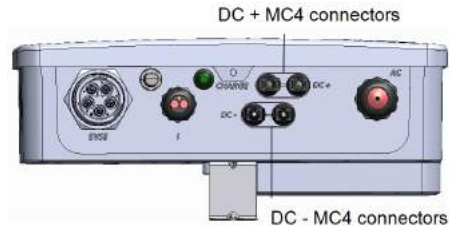

Figure 15: Connection Unit with MC4 Connectors

Selecting a Residual Current Device (RCD)

IMPORTANT SAFETY FEATURE



All SolarEdge inverters incorporate a certified internal Residual Current Device (RCD) in order to protect against possible electrocution and fire hazard in case of a malfunction in the PV array, cables or inverter. There are two trip thresholds for the RCD as required for certification (DIN VDE 0126-1-1). The default value for electrocution protection is 30 mA, and for slow rising current is 300 mA.

If an external RCD is required by local regulations, check which type of RCD is required for the relevant electric code. Install the residual-current device (RCD) in accordance with the applicable local standards and directives. SolarEdge recommends using a type-A RCD. The recommended RCD value is 100 mA or 300 mA unless a lower value is required by the specific local electric codes. When required by local regulations, the use of an RCD type B is permitted.



NOTE

For multiple inverters, an RCD per inverter is required.

In installations where the local electric code requires an RCD with a lower leakage setting, the discharge current might result in nuisance tripping of the external RCD. The following steps are recommended to avoid nuisance tripping of the external RCD:

- Select the appropriate RCD for correct operation of the installation: An RCD with a rating of 30 mA may actually trip at a leakage as low as 15 mA (according to IEC 61008). High quality RCDs will typically trip at a value closer to their rating.
- Configure the trip voltage of the inverter's internal RCD to a lower value than the trip current of the external RCD. The internal RCD will trip if the current is higher than the allowed current, but because the internal inverter RCD automatically resets when the residual currents are low it saves the manual reset.

For detailed information, refer to the *RCD Selection for SolarEdge Inverters Application Note*, available on the SolarEdge website at http://www.solaredge.com/sites/default/files/application_note_ground_fault_rcd.pdf.



Chapter 5: Activating, Commissioning and Configuring the System

You can connect communication options at this stage, as described in *Setting Up Communication* on page 51.

Once all connections are made, the system should be activated and commissioned using the Inverter SetApp mobile application. You can download the app from the Apple App Store and Google Play prior to reaching the site.



Internet connection is required for the download and for the one-time registration, however not required for using the SetApp.

Step 1: Activating the Installation

During system activation, a Wi-Fi connection is created between the mobile device and the inverter and the system firmware is upgraded.

Before activation - download, register (first time only) and log-in to SetApp on your mobile device. Internet connection is required for the download and for the one-time registration. Verify that the application is updated with the latest version.

→ **To activate the inverter:**

1. Turn ON the AC circuit breaker on the main distribution panel.
2. Open SetApp and follow the instructions on the screen (scan the inverter bar-code; move the ON/OFF/P switch to P position and release within 5 sec. back to ON (1) position). SetApp creates a Wi-Fi connection, upgrades the inverter CPU firmware and activates the inverter.

3. When the activation is complete, do one of the following:

- Select **Activate Another Inverter** to continue activating additional inverters.
- Select **Start Commissioning** for pairing and other system configuration. The Commissioning screen is displayed. Refer to the next section for more information.

Step 2: Commissioning and Configuring the Installation

This section describes how to use the SetApp menus for commissioning and configuring the inverter settings.

Menus may vary in your application depending on your system type.



→ To access the Commissioning screen:

Do one of the following:

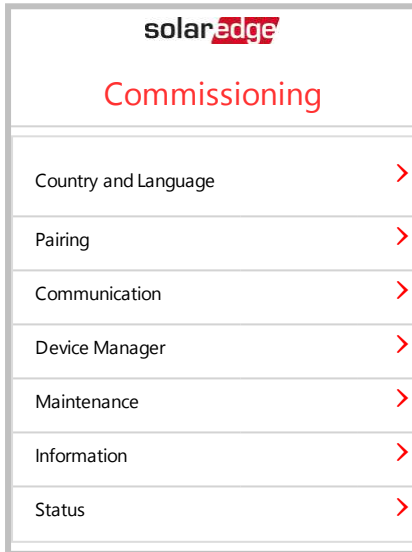
- During first time installation: Upon Activation completion, in the SetApp, tap **Start Commissioning**. The main Commissioning menu screen is displayed.



- If the inverter has already been activated and commissioned:

-  If not already ON - turn ON AC to the inverter by turning ON the circuit breaker on the main distribution panel.
-  Open SetApp and follow the instructions on the screen (scan the inverter bar-code; move the ON/OFF/P switch to P position (for less than 5 sec) and release).

The mobile device creates a Wi-Fi connection with the inverter and displays the main Commissioning screen.

In the main menus, tap the menu red arrows (>) to perform the system commissioning or configuration task. Tap the **Back** arrow (<) to return to the previous menu.

The next sections provide more information about configuration options (in addition to **Country and Language** and **Pairing**, described in *Step 2: Commissioning and Configuring the Installation* on page 36).

Setting Country and Language

1. From the Commissioning screen select **Country and Language** .
2. From the **Country** drop-down list, select the required country setting.

WARNING!



The inverter must be configured to the proper setting in order to ensure that it complies with the country grid code and functions properly with the country grids.

3. From the **Language** drop-down list, select the language.
4. Tap **Set Language**.

Pairing

1. From the main menu, select **Pairing**.
2. Tap **Start Pairing**.
3. When **Pairing Complete** is displayed, the system startup process begins:
Since the inverter is ON, the power optimizers start producing power and the inverter starts converting AC.

WARNING!



When you turn ON the inverter ON/OFF/P switch, the DC cables carry a high voltage and the power optimizers no longer output a safe output.

When the inverter starts converting power after the initial connection to the AC, the inverter enters Wakeup mode until its working voltage is reached. This mode is indicated by the flickering green inverter LED.

When working voltage is reached, the inverter enters Production mode and produces power. The steadily lit green inverter LED indicates this mode.

4. Tap **OK** to return to the main menu.

Communication

Communication settings can be configured only after communication connections are complete. Refer to *Setting Up Communication* on page 51.

1. Select the **Communication** menu to define and configure the following:
 - The communication option used by the inverter to communicate with the monitoring platform.
 - The communication option used to communicate between multiple SolarEdge devices or other external non-SolarEdge devices, such as electricity meters or loggers.
2. Tap the **Server** red arrow to set the communication method to be used for communication between devices and the SolarEdge monitoring platform. The default is LAN.



NOTE

The Server menu shows only the communication options installed in the inverter.

For detailed information about all the configuration options, refer to the *Communication Options Application Note*, available on the SolarEdge website at https://www.solaredge.com/sites/default/files/solaredge-communication_options_application_note_v2_250_and_above.pdf.



Power Control

Power control options are detailed in the *Power Control Application Note*, available on the SolarEdge website at https://www.solaredge.com/sites/default/files/application_note_power_control_configuration.pdf.



The Grid Control option may be disabled. Enabling it opens additional options in the menu.

The Energy Manager option is used for setting power export limitation, as described in the *Export Limitation Application Note*, available on the SolarEdge website at https://www.solaredge.com/sites/default/files/feed-in_limitation_application_note.pdf.



Device Manager

From the **Commissioning** menu, select **Device Manager** to configure various system Smart Energy Management devices.

For more information refer to

<https://www.solaredge.com/products/device-control#/>.



Maintenance



From the **Commissioning** menu, select **Maintenance** to configure various system settings, as described below.

- **Date and Time:** Set the internal real-time clock. If connected to the monitoring platform, the date and time are set automatically and only time zone should be set.
- **Reset Counters:** Resets the accumulated energy counters that are sent to the monitoring platform.
- **Factory Reset:** Performs a general reset to the default device settings.
- **Firmware Upgrade:** Perform a software upgrade.
- **Diagnostics:** Displays the Isolation status and power optimizer status screens. Refer to https://www.solaredge.com/sites/default/files/application_note_isolation_fault_troubleshooting.pdf.
- **Activate Standby Mode:** Enables/disables Standby Mode - for remote commissioning.
- **Grid Protection:** Available in specific countries. Enables viewing and setting grid protection values.
- **Board Replacement:** Backs up and restores the system parameters, including energy counters; Used during board replacement according to the instructions supplied with replacement kits.



Information



From the **Commissioning** menu, select **Information** to view and set various system settings, as described below.

-  **CPU Version:** The communication board firmware version
-  **DSP 1/2 Version:** The digital board firmware version



NOTE

Please have these numbers ready when you contact SolarEdge Support.

-  **Serial Number:** The inverter serial number as appears on the enclosure sticker
-  **Error Log:** Displays the last five errors, and enables resetting (clearing) the log
-  **Warning Log:** Displays the last five warnings, and enables resetting (clearing) the log

Step 3: Verifying Proper Activation and Commissioning

1. Select **Information** and verify that the correct firmware versions are installed on each inverter.
2. Select **Status** and verify that inverter is operating and producing power (see also *Viewing System Status* on page 41).
3. Verify that additional configurations were properly set by viewing the relevant Status screens.
4. Verify that the green inverter LED is steadily lit.

Your SolarEdge power harvesting system is now operational.

Viewing System Status

During normal operation, the **Status** screen displays all the inverter settings and operation status. Scroll up or down to display various status parameters as described in the following sections.

The LED indication provides more information about system performance; Refer to *LEDs* on page 24.

→ To access the Status screen:

From the **Commissioning** menu select **Status**. The main inverter Status screen is displayed (see below).

A red or orange icon (for example: ) may appear at the top left corner of a status cell, indicating an error. The color indicates error severity (red is top severity). The error description or information appears on the screen. Tap the error line for more information and troubleshooting instructions, and refer to *Errors and Troubleshooting* on page 61.

A gray clock icon () may appear at the top left corner of a status cell, indicating a temporary status, such as a connection process. When the process is complete, the icon disappears and a constant status message is displayed.

Main Inverter Status

solar edge		
Status		
Inverter		
SN 07318000C		
Power	Voltage	Frequency
7.6 kW	240Vac	60 Hz
P_OK: 15 of 30	Server Comm.	
Optimizers Connected	S_OK (LAN)	
Status	Switch	
Production	OFF	
CosPhi	Limit	Country
1.00	No Limit	Netherlands
Voltage	Temp	Fan
380 Vdc	20 C	OK
Switch Off. Production disabled >		
Commissioning >		

- Inverter:** The inverter serial number
- Power:** The AC output power
- Voltage (Vac):** The AC output voltage
- Frequency:** The AC output frequency
- P_OK: xxx of yy:** There is a connection to the power optimizers and at least one power optimizer is sending monitoring data. XXX is the number of power optimizers for which telemetries have been received in the last two hours. YYY is the number of paired power optimizers identified during the most recent pairing process. If XXX and YYY are not equal, there may be a problem in one or more power optimizers.
- S_OK:** The connection to the monitoring platform. (**Server Connected** appears only if the inverter is connected to the monitoring platform).

- **Status:** The inverter operation status: Off, Not Paired, Night Mode, Error, Pairing, or Production.
- **Switch:** Indicates the position of the inverter ON/OFF/P switch: On, Off, or P position.
- **CosPhi:** Indicates the ratio between active and reactive power. A negative value indicates a lagging CosPhi.
- For more information, refer to the *Power Control Application Note*, available on the SolarEdge website at https://www.solaredge.com/sites/default/files/application_note_power_control_configuration.pdf.
- **Limit:** The inverter maximum output power
- **Country:** The selected country and grid setting
- **Voltage (Vdc):** The DC input voltage
- **Temp** (°C or °F): The inverter heat sink temperature





Site Status

The Site status screen shows the accumulated status of all inverters connected to a master inverter in a chain (bus) and the master inverter status.

solar edge		
Status		
Site		
Production	Limit	Inverters
90 kW	1.00 MW	10/10
Inverter		
SN 07318000C		
Power	Voltage	Frequency
100 kW	277 Vac	60.9 Hz
P_OK: 31 Of 31	S_OK	
Optimizers Connected	Server Connected	
Status	⚠	Switch
Production		OFF
CosPhi	Limit	Country
1.00	Export	ITA
⚠ Switch Off. Production disabled >		
Commissioning		>

Site status:











-  **Production:** The AC output power
-  **Limit:** Limitation setting (Export or Production)
-  **Inverters:** Number of connected inverters in the cluster, including the master

Communication Status

This screen displays the status of connection option(s): LAN, RS485, Wi-Fi, cellular or ZigBee Plug-in.

Communication		
LAN Connected	RS485-1 Modbus 2 of 2	RS485-2 SE Slave None
Cellular N/A	Wi-Fi NC	ZigBee NC

For each communication option, one of the following statuses is displayed:

-  **Connected:** The inverter established a successful connection and communication with the specified server port
-  **NC:** Not Connected
-  **S_OK:** The connection to the monitoring platform is successful (should appear only if the is connected to the server)
-  **N/A :** Not Applicable
-  **x of y:** Number of devices connected out of all devices
-  Temporarily displayed (with a ⌚ clock sign):
 -  **Initializing communication**
 -  **Connecting** to a network
 -  **Connecting** to SolarEdge servers
-  **Error message** (with the 😞 sign)

Inverter Energy Status

Displays the total energy produced during the last day, month, year and since inverter installation.



Inverter Energy		
Today	This Month	This Year
45 kWh	1.14 MWh	13.68 MWh
Total: 41.03 MWh		

 **Today:** Since midnight

 **This Month:** Since 1st of the current month









 **This Year:** Since January 1st

 **Total (Wh):** The inverter total energy. If an external meter is installed, the value displayed in this line depends on the meter type connected to the inverter and its location:

-  If a bidirectional meter is connected at the consumption point, this value is the consumed energy.
-  If the meter is installed at the production point, this value is the energy produced by the site.
-  If the meter is installed at the grid connection point, this value is the energy exported to the grid.

Meter Status

Meters	
Production Meter	
SN: XXXXXXXX	
RS485-2	Status
Modbus ID #2	OK
Power	Energy
7.60 kW	13.68MWh
Export Meter	
SN: XXXXXXXX	
GPIO S0 meter	
1000 pulses per kWh	
Power	Energy
7.60 kW	13.68MWh
Commissioning >	

-  **Type and function:** Displays the meter functionality (Production, Export, Import, Export+Import).
-  **Status:** Displays OK if the meter is communicating with the inverter.
-  **<Error message>:** If there is a meter error, it is displayed in this line.
-  **Power:** Depending on the meter type connected to the inverter, this line displays the exported or imported power.
-  **Energy:** The total energy read by the meter. The value displayed in this line depends on the meter type connected to the inverter and its location:
 -  If a bidirectional meter is connected at the consumption point, this value is the consumed energy.
 -  If the meter is installed at the production connection point, this value is the energy produced by the site.
 -  If the meter is installed at the grid connection point, this value is the energy exported to the grid.





NOTE

This data is accumulated according to an internal real-time clock.

EV Charging Status

When the EV charger is activated, this screen displays the EV charging status , according to the charging mode.

solar edge		
Status		
Inverter Energy		
Today	This Month	This Year
45 kWh	1.14 Wh	13.68 Wh
Total 41.03 MWh		
EV Charger		
Car	Charger	
Charging	3.81 kW	
Energy Added 163 Wh		

-  **EV / Car Status:** Connected / Disconnected / Charging
-  **Charger:** Charging power x.xkW / Ready / Initializing
-  **Energy Added:** 0 - 999 kWh added to the EV battery.
After disconnecting the EV charger the last charged energy is displayed.

Reporting and Monitoring Installation Data

NOTE



Monitoring the site requires connecting the inverter to the monitoring platform, using any of the wired or wireless options available from SolarEdge. Refer to *Setting Up Communication* on page 51.

The Monitoring Platform

The monitoring platform provides enhanced PV performance monitoring and yield assurance through immediate fault detection and alerts at the module, string and system level.

Using the platform, you can:

- View the latest performance of specific components.
- Find under-performing components, such as modules, by comparing their performance to that of other components of the same type.
- Pinpoint the location of alerted components using the physical layout.

The monitoring platform enables accessing site information, including up-to-date information viewed in a physical or logical view:

- **Logical Layout:** Shows a schematic tree-layout of the components in the system, such as: inverters, strings, modules, meters and sensors, as well as their electrical connectivity. This view enables you to see which modules are connected in each string, which strings are connected to each inverter, and so on.
- **Physical Layout:** Provides a bird's eye view of the actual placement of modules in the site, and allows pinpoint issues to the exact location of each module on a virtual site map.

If you do not report the mapping of the installed power optimizers, the monitoring platform will show the logical layout indicating which power optimizers are connected to which inverter, but will not show strings or the physical location of power optimizers.

The monitoring platform includes a built-in help system, that guides you through the monitoring functionality.

For more information, refer to <https://www.solaredge.com/products/pv-monitoring#/>.



Creating Logical and Physical Layout using Installation Information

To display a logical layout, insert the inverter serial number in the new site created in the monitoring platform. When the communication between the inverter and the monitoring server is established, the logical layout is displayed.

To display a physical layout, you need to map the locations of the installed power optimizers. To map the locations, use one of the methods described in the next sections.

Designer

Designer recommends inverter and power optimizer selection per site size and enables report generation. You can create a project in Designer and export the site design with the string layout to the monitoring platform.

For more information, refer to

<https://www.solaredge.com/products/installer-tools/designer#/>.



Mapper Application

Use the Mapper smart phone application to scan the power optimizer and inverter 2D bar-codes and create a virtual map of a PV site for enhanced monitoring and easier maintenance.

The Mapper application is integrated with the monitoring platform and enables:

- Simple on-site registration of new systems.
- Creating, editing and verifying system physical layout.
- Scanning and assigning the power optimizer serial number to the correct module in the system physical layout.

For detailed information, refer to the *Mapper* demo movies:

■ [Creating new sites using the Mapper mobile application](#)



■ [Mapping existing sites using the Mapper mobile application](#)



Physical Layout Editor

1. If you are a registered installer, access the monitoring platform site creation page at <https://monitoring.solaredge.com/solaredge-web/p/home#createSites>. If you have not yet signed up, go to <https://monitoring.solaredge.com/solaredge-web/p/createSelfNewInstaller>.
2. Fill out all required information in the screen, which includes information about your installation, as well as details about its logical and physical mapping.



Using a Paper Template

Fill out the Physical Layout Template (downloadable from the SolarEdge website <http://www.solaredge.com/files/pdfs/physical-layout-template.pdf>) using the detachable 2D barcode stickers on each power optimizer. Once the form is completed, use the Mapper to scan the 2D codes and create the map in the monitoring platform. Optionally, you can send the sticker sheet to SolarEdge Support for physical layout creation.



Chapter 6: Setting Up Communication

The inverter sends the following information to the monitoring platform:

- Power optimizer information received via the DC power lines (the PV output circuit)
- Inverter information
- Information of any other connected devices

This chapter describes setting up communication between:

- The inverter and the monitoring platform through the Internet (wired/ wireless), or through a cellular connection
- Multiple inverters for a master/slave configuration

Communication setup is not required for power harvesting, however it is needed for using the monitoring platform.

CAUTION!



When connecting the communication cables, make sure that the ON/OFF/P switch at the bottom of the inverter (and the switch of the Connection Unit if applicable) is turned OFF, and the AC is turned OFF.

When configuring the communication parameters, make sure that the ON/OFF/P switch (and the switch of the Connection Unit if applicable) is OFF, and the AC is turned ON.

Communication Options

The following types of communication can be used to transfer the monitored information from the inverter to the monitoring platform.

Only communication products offered by SolarEdge are supported.

Ethernet

Ethernet is used for a LAN connection. For connection instructions refer to *Creating an Ethernet (LAN) Connection* on page 55

RS485

The following RS485 ports are available:

- RS485-1: Connects to the internal EV Charger circuit and (optionally) for connecting other ModBus devices on the same bus, such as external meters.

- RS485-2: Enables connection of multiple SolarEdge devices and of non-SolarEdge devices over the same bus.

For connection instructions refer to *Creating an RS485 Bus Connection* on page 58

Wi-Fi

This communication option enables using a Wi-Fi connection for connecting to the monitoring platform.

The Wi-Fi access point is built into the inverter. An antenna is required and available from SolarEdge for connection to the monitoring platform.

Cellular

This wireless communication option (purchased separately) enables using a cellular connection to connect one or several devices (depending on the data plan used) to the monitoring platform.



The Cellular Plug-in is provided with a user manual, which should be reviewed prior to connection. Refer to

<https://www.solaredge.com/sites/default/files/cellular-plug-in-for-setapp-installation-guide.pdf>

ZigBee

This option enables wireless connection, and requires a ZigBee Plug-in and an external antenna. ZigBee connection is used for connection of one or several devices to a SolarEdge ZigBee Gateway, for wireless communication to the SolarEdge monitoring platform.

The ZigBee Gateway is provided with an installation guide, which should be reviewed prior to connection. Refer to

<https://www.solaredge.com/sites/default/files/se-zigbee-gateway-for-setapp-installation-guide.pdf>



Communication Connectors

A communication gland with multiple openings is used for connection of the various communication options. The table below describes the functionality of each gland opening. Unused openings should remain sealed.

Opening for cable size (diameter)	Connection type
2.5 - 5 mm	RS485
4.5 - 7 mm, with cut	Ethernet (CAT5/6)
2 - 4 mm, with cut	Antenna cable for wireless communication



Figure 16: Communication Gland

The communication board has a standard RJ45 terminal block for Ethernet connection, a 6-pin terminal block for RS485 connection, and an 8-pin connector for power control devices.

The SolarEdge ZigBee or Wi-Fi Plug-in and the GSM Plug-in can be connected to the communication board for optional wireless connection.

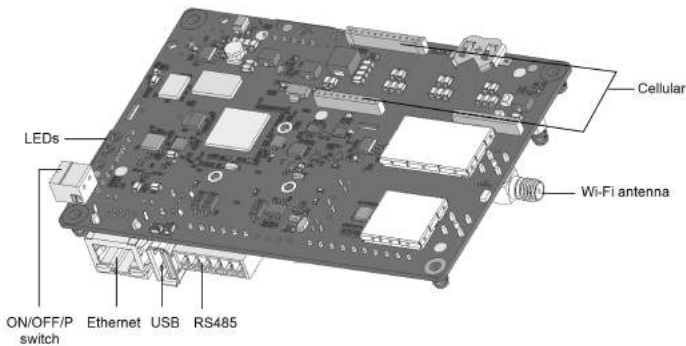

Figure 17: Communication board connectors

Removing the Inverter Cover

1. Switch the inverter ON/OFF/P switch to OFF. Wait 5 minutes for the capacitors to discharge.
2. Turn the Safety Switch (if applicable) to OFF.
3. Disconnect the AC to the inverter by turning OFF the circuit breakers on the distribution panel.
4. Open the Allen screws of the inverter cover and carefully pull the cover horizontally before lowering it.
5. Open the inverter cover (see *Figure 18*).

CAUTION!



When removing the inverter cover, make sure not to damage the internal components. SolarEdge will not be held responsible for any components damaged as a result of incautious cover removal.

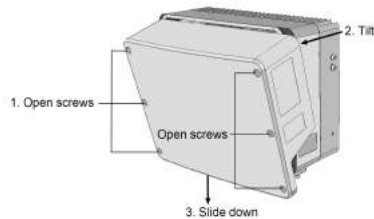

Figure 18: Removing the inverter cover

Removing the Connection Unit Cover

1. Turn OFF the Connection Unit and the AC breaker of the distribution panel.
2. Open the Connection Unit cover: Release the four Allen screws and remove the cover.

CAUTION!



When removing the Connection Unit cover, make sure not to damage the internal components. SolarEdge will not be held responsible for any components damaged as a result of incautious cover removal.

Creating an Ethernet (LAN) Connection

This communication option enables using an Ethernet connection to connect the inverter to the monitoring platform through a LAN.

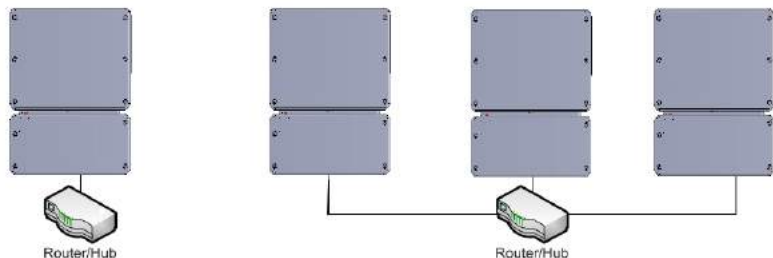

Figure 19: Example of Ethernet connection

Ethernet cable specifications:

- Cable type – a shielded Ethernet cable (Cat5/5E STP) may be used
- Maximum distance between the inverter and the router – 100 m/ 330 ft.

NOTE



If using a cable longer than 10 m / 33 ft in areas where there is a risk of induced voltage surges by lightning, it is recommend to use external surge protection devices.

For details refer to:

http://www.solaredge.com/files/pdfs/lightning_surge_protection.pdf.



➔ **To connect the Ethernet cable:**

1. Remove the inverter cover as described in *Removing the Inverter Cover* on page 54.
2. Open the communication gland.



CAUTION!

The gland includes a rubber waterproof fitting, which should be used to ensure proper sealing.

3. Remove the plastic seal from one of the large openings.
4. Remove the rubber fitting from the gland and insert the CAT5/6 cable through the gland and through the gland opening in the inverter.
5. Push the cable into the cut opening of the rubber fitting.

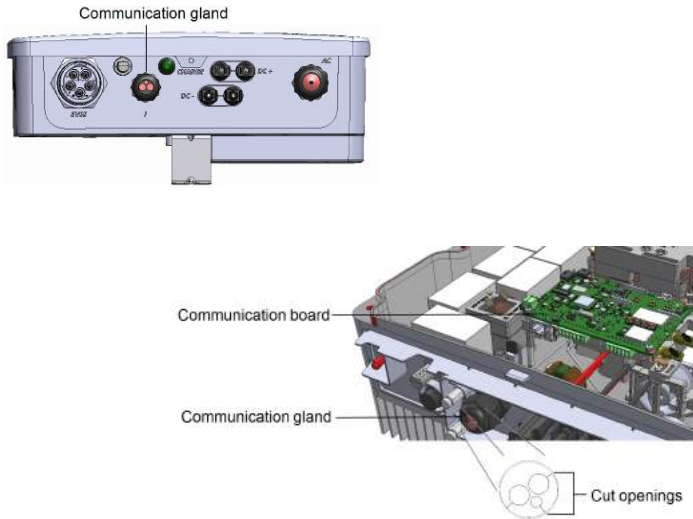

Figure 20: Communication gland and rubber fitting

CAT5/6 standard cables have eight wires (four twisted pairs), as shown in the diagram below. Wire colors may differ from one cable to another. You can use either wiring standard, as long as both sides of the cable have the same pin-out and color-coding.

RJ45 Pin #	Wire Color ⁽¹⁾		10Base-T Signal 100Base-TX Signal
	T568B	T568A	
1	White/Orange	White/Green	Transmit+
2	Orange	Green	Transmit-
3	White/Green	White/Orange	Receive+
4	Blue	Blue	Reserved
5	White/Blue	White/Blue	Reserved
6	Green	Orange	Received-
7	White/Brown	White/Brown	Reserved
8	Brown	Brown	Reserved

(1)The inverter connection does not support RX/TX polarity change. Supporting crossover Ethernet cables depends on the switch capabilities.

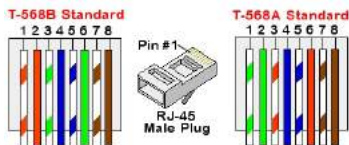

Figure 21: Standard cable wiring

6. Use a pre-terminated cable to connect via gland #1 to the RJ45 plug on the inverter's communication board or, if using a spool of cable, connect as follows:
 - a. Insert the cable through the gland.
 - b. Remove the cable's external insulation using a crimping tool or cable cutter and expose eight wires.
 - c. Insert the eight wires into an RJ45 connector, as described in *Figure 21*
 - d. Use a crimping tool to crimp the connector.
 - e. Connect the Ethernet connector to the RJ45 port on the communication board.

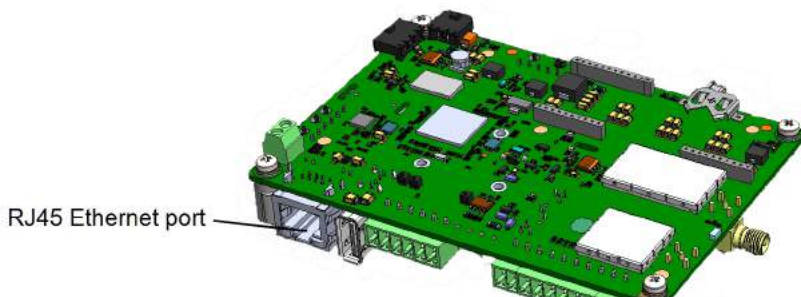

Figure 22: The RJ45 Ethernet connection

7. For the switch/router side, use a pre-terminated cable or use a crimper to prepare an RJ45 communication connector: Insert the eight wires into the RJ45 connector in the same order as above (*Figure 21*).
8. Connect the cable RJ45 connector to the RJ45 port of the Ethernet switch or router. You can connect more than one inverter to the same switch/router or to different switches/routers, as needed. Each inverter sends its monitored data independently to the SolarEdge monitoring platform.
9. The inverter is configured by default to LAN. If reconfiguration is required:

- a. Make sure the ON/OFF/P switch is OFF.
- b. Turn ON the AC to the inverter by turning ON the circuit breaker on the main distribution panel.
- c. Configure the connection as described in *Communication* on page 38.

NOTE

If your network has a firewall, you may need to configure it to enable the connection to the following address:





- Destination Address: prod.solaredge.com
- TCP Port: 22222 (for incoming and outgoing data)

10. Verify the connection, as described in *Verifying the Connection* on page 59.

Creating an RS485 Bus Connection

The RS485 option enables creating a bus of connected inverters, consisting of up to 31 slave inverters and 1 master inverter. Using this option, inverters are connected to each other in a bus (chain), via their RS485 connectors. The first and last inverters in the chain must be terminated as described on page 58.

RS485 wiring specifications:

-  Cable type: Min. 3-wire shielded twisted pair (a shielded Ethernet cable (Cat5/5E STP) may be used)
-  Wire cross-section area: 0.2- 1 mm²/ 24-18 AWG (a CAT5 cable may be used)
-  Maximum nodes: 32
-  Maximum distance between first and last devices: 1 km /3300 ft.

NOTE

If using a cable longer than 10 m/ 33 ft in areas where there is a risk of induced voltage surges by lightning, it is recommend to use external surge protection devices. For details refer to:

https://www.solaredge.com/sites/default/files/lightning_surge_protection.pdf.



If grounded metal conduit are used for routing the communication wires, a lightning protection device is not required.

If not using surge protection, connect the grounding wire to the first inverter in the RS485 chain; make sure the grounding wire is not in contact with other wires. For inverters with a Connection Unit, connect the grounding wire to the grounding bus-bar in the Connection Unit.

→ To connect to the monitoring platform:

1. Designate a single inverter as the connection point between the RS485 bus and the monitoring platform. This inverter will serve as the master inverter.
2. Connect the master to the monitoring platform via the LAN option (refer to *Creating an Ethernet (LAN) Connection* on page 55 or any of the other options).

→ To configure the RS485 bus:

All inverters are configured by default as slaves. To configure the master:

1. Verify the ON/OFF/P switch is OFF.
2. Verify that AC is on.
3. Use SetApp to access the **Commissioning** menu screen as described in *Communication* on page 38.
4. From the **Commissioning** menu tap **Communication**. The Communication screen is displayed.
5. Select the following to configure the connection:
 - Server → **LAN, Cellular or Wi-Fi**
 - RS485-2 → Protocol → SolarEdge → **SolarEdge Master**
 - RS485-2 → **Slave Detect**

The system starts automatic detection of the slave inverters connected to the master inverter. The inverter should report the correct number of slaves. If it does not, verify the connections and terminations.

6. To check the slave IDs and last communication time, select **RS4852** → **Slave List**.
7. Verify the connection of the master to the monitoring platform, as described in the next section.

Verifying the Connection

After connecting and configuring a communication option, perform the following steps to check that the connection to the monitoring server has been successfully established.

1. Access the Status screen:
 - a. If not already ON - turn ON AC to the inverter by turning ON the circuit breaker on the main distribution panel.
 - b. Open SetApp and follow the instructions on the screen (scan the inverter barcode; move the ON/OFF/P switch to P position (for less than 5 sec) and release).
The mobile device creates a Wi-Fi connection with the inverter and displays the main Commissioning screen.
2. Check that **S_OK - Server Connected** status appears in the main inverter section.
3. Scroll down to the Communication section and check that the communication options are as required. For more information refer to *Communication Status* on page 45.

Appendix A: Errors and Troubleshooting

This appendix describes general system problems, and how to troubleshoot them. For further assistance, contact SolarEdge Support.

Identifying Errors

Errors may be indicated in various system interfaces: On the inverter bottom panel, a red LED indicates an error. In the monitoring platform and SetApp, errors are displayed with codes. For more information on the codes displayed for error and warning messages, refer to <http://www.solaredge.com/sites/default/files/se-inverter-installation-guide-error-codes.pdf>. This document describes errors that appear in SetApp, monitoring platform, and LCD (for inverters with LCD). To identify the error types, use the methods described below.



→ To identify the error type using the inverter LEDs:

1. Move the ON/OFF/P switch to **P** position for **less** than 5 seconds and release it.
2. Observe the LED lights and use the following table to identify the error type. For more information, refer to <https://www.solaredge.com/leds>.



Error type	LED color and state		
	Red	Green	Blue
Arc detected	ON	OFF	OFF
Isolation or RCD problem	Blinking	OFF	OFF
Grid error	OFF	ON	OFF
High temperature	OFF	Blinking	OFF
Pairing failed	OFF	OFF	ON
Other issue	OFF	OFF	Blinking

→ To identify the error type using the monitoring platform:

1. Open the site dashboard and click the **Layout** icon.
2. Right-click the inverter and select **Info** from the menu. The inverter details window is displayed.
3. Click the **Errors** tab. The list is displayed.

EV Charger-related Troubleshooting

For the following system errors, when an error occurs, the red LED lights ON and the buzzer beeps 10 times.

The error message is displayed on the SolarEdge mobile app screen.

If the error persists- contact SolarEdge Support.

Error code	Displayed Error message	Description and Troubleshooting
3x85	EVSE Comm. Error	An internal communication error. When this error occurs, the red LED is not lit, the buzzer does not beep and charging is not affected. Check that the internal connections on the communication board are properly done.
1Cx1; 1Cx8	Over Current Press Charge Now	EV Charger AC over current. <ul style="list-style-type: none"> • Press the Charge Now pushbutton on the Connection Unit, see <i>Figure 5</i> -or- • Tap Charge Now on the EV Charger tab of the Monitoring App
1Cx2; 1xC9	Over Voltage Press Charge Now	EV Charger AC voltage too high. <ul style="list-style-type: none"> • Press the Charge Now pushbutton on the Connection Unit, see <i>Figure 5</i> -or- • Tap Charge Now on the EV Charger tab of the Monitoring App
1Cx3,Cx14; 1Cx15	Ground Fault (RCD) Press Charge Now	EV Charger ground fault detected. <ul style="list-style-type: none"> • Press the Charge Now pushbutton on the Connection Unit, see <i>Figure 5</i>

Error code	Displayed Error message	Description and Troubleshooting
		-or- <ul style="list-style-type: none"> • Tap Charge Now on the EV Charger tab of the Monitoring App
1Cx4; 1Cx5; 1Cx12 -1Cx13	Internal Error Disconnect from EV	Internal error. <ul style="list-style-type: none"> • Disconnect the EV Charger cable from the vehicle. • Turn the inverter AC circuit breaker OFF and ON. • Reconnect the EV Charger Cable to the vehicle
1CxB/D; 1Cx10 - 1Cx11	Interface Error (Pilot) Press Press Charge Now	<ul style="list-style-type: none"> • Press the Charge Now pushbutton on the Connection Unit, see <i>Figure 5</i> -or- <ul style="list-style-type: none"> • Tap Charge Now on the EV Charger tab of the Monitoring App
1Cx6	Ground Disconnected Disconnect from EV	Ground Disconnected. <ul style="list-style-type: none"> • Disconnect the EV Charger cable from the vehicle. • Contact SolarEdge Support.
1Cx7	Over Temperature	EV Charger over temperature Verify proper clearances around the inverter and EV Charger Cable. After verification reconnect the EV charger cable to the EV.
1CxA	Under Voltage Press Charge Now	EV Charger AC voltage too low. <ul style="list-style-type: none"> • Press the Charge Now pushbutton on the Connection Unit, see <i>Figure 5</i> -or-

Error code	Displayed Error message	Description and Troubleshooting
		<ul style="list-style-type: none"> • Tap Charge Now on the EV Charger tab of the Monitoring App
1CxC	Vent not supported Disconnect from EV	The SolarEdge EV charger does not charge vehicles that require ventilation while charging. If this error occurs, the vehicle cannot be charged.
1CxE;1CxF	Charging retries ended Disconnect from EV	Charging retries ended <ul style="list-style-type: none"> • Disconnect the EV Charger cable from the vehicle. • Contact SolarEdge Support.

Power Optimizer Troubleshooting

Problem	Possible cause and troubleshooting
Pairing failed	<p>Power optimizers are shaded.</p> <p>If you connected the inverter to the monitoring platform, retry pairing remotely (during sunlight). Make sure to leave the inverter ON/OFF/P switch ON and that S_OK appears in the status screen.</p>
String voltage is 0V	<p>Power optimizer (s) output is disconnected.</p> <p>Connect all power optimizer outputs.</p>
String voltage not 0V but lower than number of optimizers	<p>Power optimizer(s) not connected in the string.</p> <p>Connect all power optimizers.</p>
	<p>Module(s) not connected properly to power optimizer inputs (not applicable to smart modules).</p> <p>Connect the modules to the optimizer inputs.</p>
	<p>String reverse polarity.</p> <p>Check string polarity using a voltmeter and correct if needed.</p>

Problem	Possible cause and troubleshooting
<p data-bbox="103 512 487 571">String voltage is higher than number of optimizers</p> <div data-bbox="112 587 481 794" style="border: 1px solid black; padding: 5px;"> <p data-bbox="176 587 294 611">WARNING!</p> <p data-bbox="176 624 449 794">If the measured voltage is too high, the installation may not have a safe low voltage. PROCEED WITH CARE! A deviation of $\pm 1\%$ per string is reasonable.</p> </div>	<p data-bbox="493 185 1003 244">Extra power optimizer(s) connected in the string (not applicable to smart modules).</p> <p data-bbox="493 260 986 319">Check if an extra power optimizer is connected in the string. If not – proceed to next solution.</p> <p data-bbox="493 335 964 427">A module is connected directly to the string, without a power optimizer (not applicable to smart modules).</p> <p data-bbox="493 443 997 571">Verify that only power optimizers are connected in the string and that no module outputs are connected without a power optimizer. If the problem persists, proceed to the next step.</p> <p data-bbox="493 579 829 603">Power optimizer(s) malfunction.</p> <ol data-bbox="493 619 1006 1126" style="list-style-type: none"> <li data-bbox="493 619 986 678">1. Disconnect the wires connecting the power optimizers in the string. <li data-bbox="493 694 997 901">2. Measure the output voltage of each power optimizer to locate the power optimizer that does not output 1V safety voltage. If a malfunctioning power optimizer is located, check its connections, polarity, module, and voltage. <li data-bbox="493 917 1006 1126">3. Contact SolarEdge Support. Do not continue before finding the problem and replacing the malfunctioning power optimizer. If a malfunction cannot be bypassed or resolved, skip the malfunctioning power optimizer, thus connecting a shorter string.

Appendix B: Mechanical Specifications

The following figure provides inverter dimensions in mm [in].

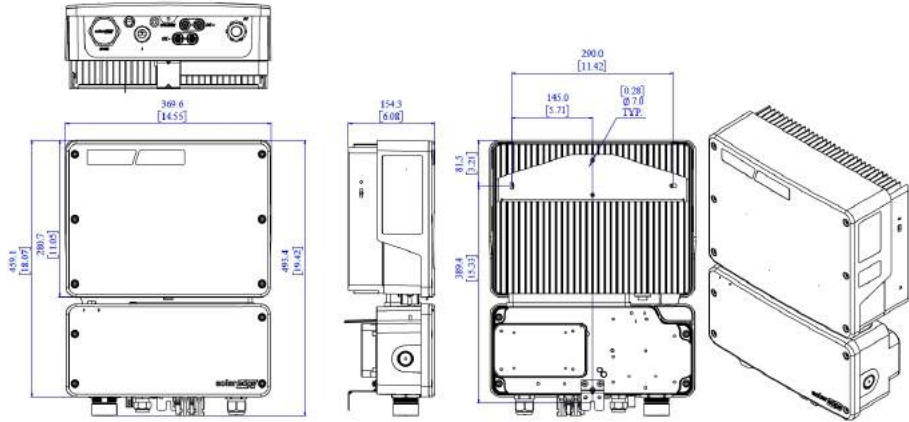

Figure 23: Inverter dimensions

Appendix C: Replacing and Adding System Components



NOTE

If you are permanently disassembling the installation or part of it, make sure to use the disposal methods dictated by local regulations.

Fuse Replacement

The inverter is equipped with a fuse, located at the top right corner of the inverter. Fuse replacement kits are available from SolarEdge or you can use other fuses with identical ratings.

1. Turn OFF the inverter ON/OFF/P switch, and wait until the green LED is blinking, indicating that the DC voltage is safe (<50V), or wait five minutes before continuing to the next step.
1. Turn OFF the Connection Unit.
2. Open and remove the inverter cover.
3. Remove the existing fuse from the upper corner of the inverter and replace with a new fuse.
4. Close the inverter cover.

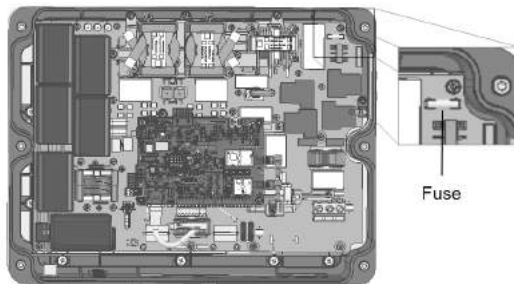

Figure 24: Inverter fuse

5. Turn ON:
 - The inverter ON/OFF/P switch
 - The Connection Unit
6. Verify proper system operation.

Replacing an Inverter

1. Turn OFF the inverter ON/OFF/P switch, and wait until the green LED is blinking, indicating that the DC voltage is safe (<50V), or wait five minutes before continuing to the next step.
2. Turn OFF the Connection Unit.
3. Disconnect the AC to the inverter by turning OFF the AC circuit breaker of the distribution panel.
4. Open the Connection Unit cover: Release the four Allen screws and remove the cover.
5. Open the inverter cover as described in *Removing the Inverter Cover* on page 54.
6. Disconnect the DC wires from the inverter and the AC wires from the Connection Unit.

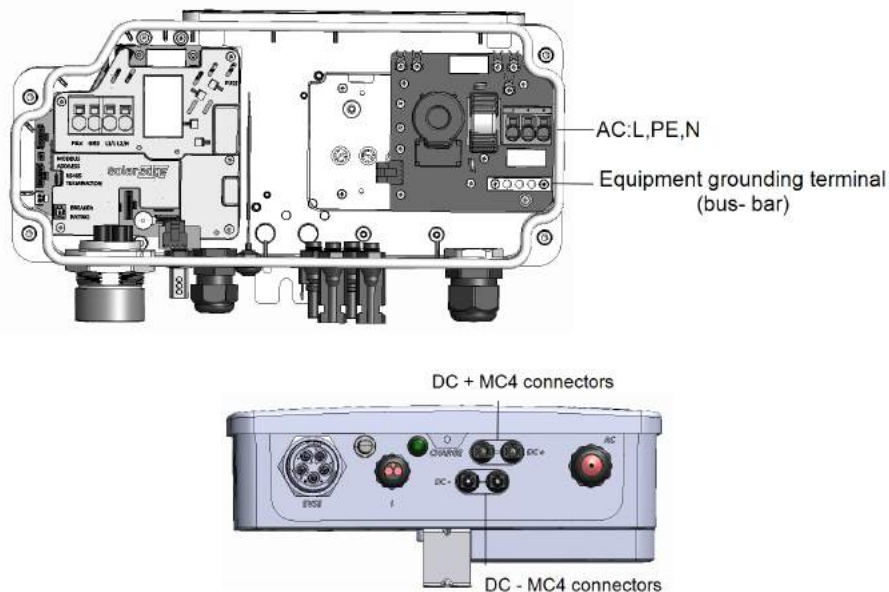

Figure 25: DC and AC connections

7. Disconnect the wires connected between the inverter and the Connection Unit:
 - Antenna cable from the communication board
 - RS485 connection from the communication board
 - Grounding cable

- Disconnect the Connection Unit from the inverter by opening the two clips securing the Connection Unit to the inverter: Carefully place a screwdriver between the clip and the enclosure and pull the clip.

Figure 26: Disconnecting the Connection Unit from the inverter

- Remove the screws securing the inverter to the mounting brackets and lift the inverter from the mounting bracket.

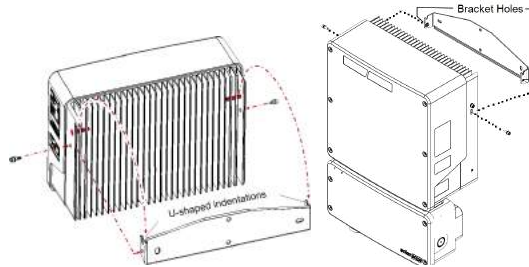

Figure 27: Mounting brackets



NOTE

If you remove the old inverter and do not immediately install a new one, use insulation tape to isolate each of the AC and DC wires

- Place the new inverter on the mounting brackets and secure it using the screws.
- Insert the wires from the Connection Unit into the openings in the inverter and the ferrite bead.
- Fasten the two clips securing the Connection Unit to the inverter.
- Reconnect the cables: Follow the instructions of *Installing the Inverter* on page 23.
- Close the inverter and Connection Unit covers.
- Perform the commissioning steps as described in *Activating, Commissioning and Configuring the System* on page 35.

Replacing the Connection Unit

- Turn OFF the inverter ON/OFF/P switch, and wait until the green LED is blinking, indicating that the DC voltage is safe (<50V), or wait five minutes before continuing to the next step.
- Turn OFF the Connection Unit and the AC breaker of the distribution panel.
- Open the Connection Unit cover: Release the four Allen screws and remove the cover.

4. Open the inverter cover as described in *Removing the Inverter Cover* on page 54.
5. Disconnect the DC wires from the inverter and the AC wires from the Connection Unit.
6. Disconnect the wires connected between the inverter and the Connection Unit:
 - Antenna cable from the communication board
 - RS485 connection from the communication board
 - Grounding cable
7. Open the Connection Unit bracket screws.

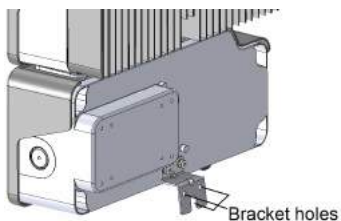
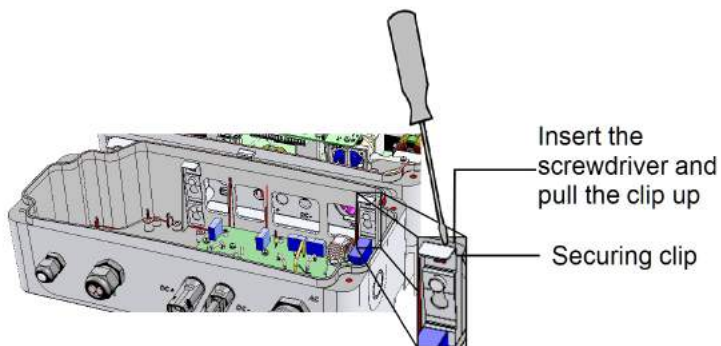

Figure 28: Connection Unit bracket

8. Disconnect the Connection Unit from the inverter by opening the two clips securing the Connection Unit to the inverter: Carefully place a screwdriver between the clip and the enclosure and pull the clip.



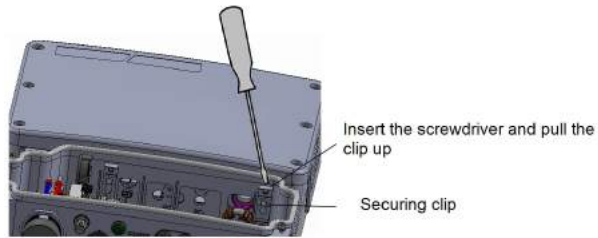







Figure 29: Disconnecting the Connection Unit from the inverter

9. Detach the Connection Unit from the inverter.
10. Place the new Connection Unit and secure it to the inverter using the clips.
11. Insert the wires from the inverter into the openings in the Connection Unit and the ferrite bead.
12. Reconnect the cables: Follow the instructions of *Installing the Inverter* on page 23.
13. Close the inverter cover.
14. Fasten the Connection Unit bracket using a standard bolt.
15. Perform the commissioning steps as described in *Activating, Commissioning and Configuring the System* on page 35.

Appendix D: SafeDC™

When AC supply to the inverter is shut off (by shutting off the AC breaker at the site), or when the inverter ON/OFF/P switch is turned to OFF, the DC voltage drops to a safe voltage of per optimizer.

The SolarEdge inverters are certified for compliance with the following standards as disconnection devices for PV generators, meaning that they can replace a DC disconnect:

-  IEC 60947-3:1999 + Corrigendum: 1999 + A1:2001 + Corrigendum 1:2001 + A2:2005;
-  DIN EN 60947-3
-  VDE 0660-107:2006-03
-  IEC 60364-7-712:2002-05
-  DIN VDE 0100-712:2006-06.

In compliance with these standards, the disconnection mechanism operates as follows:

1. Turn the inverter ON/OFF/P switch, located at the bottom of the inverter, to OFF, or disconnect the AC by shutting off the AC breaker at the site. The DC voltage displayed on the SetApp screen begins to decrease.
2. When the DC voltage reaches a safe voltage, the PV connectors at the input to the inverter can be disconnected. A galvanic separation then exists between the PV array and the inverter.

Technical Specifications - EV Charging Single Phase Inverter (Europe & APAC)

Inverter Specifications

	SE3680H	SE4000H	SE5000H	SE6000H	Unit
OUTPUT - AC (LOADS / GRID)					
Rated AC Power Output	3680	4000	5000 ⁽¹⁾	6000	VA
Max AC Power Output	3680	4000	5000 ⁽¹⁾	6000	VA
AC Output Voltage (nominal)	220 / 230				Vac
AC Output Voltage Range	184 - 264.5				Vac
AC Frequency (Nominal)	50 / 60 ± 5				Hz
Maximum Continuous Output Current	16	18.5	23	27.5	A
Max. output fault current and duration	16 / 20	18.5 / 20	23 / 20	27.5 / 20	A / ms
Residual Current Detector / Residual Current Step Detector	300 / 30				mA
Inrush current AC (Peak/ Duration)	2.8/20				Aac(rms) / ms
Max. output overcurrent protection	38				A
Power factor range	1 (adjustable from -0.9 to +0.9)				
Total harmonic distortion	< 3				%
Protective class	Class I				
Utility Monitoring, Islanding Protection, Country Configurable Thresholds	Yes				
Overvoltage category	III				
INPUT - DC					

(1)4600VA in Germany

	SE3680H	SE4000H	SE5000H	SE6000H	Unit
Maximum DC Power	5700	6200	7750	9300	W
Transformer-less, Ungrounded	Yes				
Maximum Input Voltage	480				Vdc
Nominal DC Input Voltage	380				Vdc
Maximum Input Current	10.5	11.5	13.5	16.5	Adc
Reverse-Polarity Protection	Yes				
Ground-Fault Isolation Detection	600 kΩ Sensitivity				
Maximum Inverter Efficiency	99.2				%
CEC Weighted Efficiency	99				%
Nighttime Power Consumption	< 2.5				W
ADDITIONAL FEATURES					
Supported Communication Interfaces	RS485, Ethernet, ZigBee (optional), Cellular (Optional), Wi-Fi				
STANDARD COMPLIANCE					
Safety - Inverter	IEC-62109-1/2				
Grid Connection Standards	UTE C15-712, G83/2, G59/3, CEI-021, EN 50438, IEC61727, IEC62116, ÖNORM, TF3.2.1, C10-11, NRS 097-2-1, VDE-AR-N-4105, VDE 0126-1-1, AS-4777				
Emissions	IEC61000-6-2, IEC61000-6-3, IEC61000-3-11, IEC61000-3-12, FCC Part 15 Class B				
RoHS	Yes				

	SE3680H	SE4000H	SE5000H	SE6000H	Unit
INSTALLATION SPECIFICATIONS					
AC output - Supported Cable Diameter	9 - 16				mm
AC - Supported Wire Cross Section	1 - 13				mm ²
Dimensions (HxWxD)	450 x 370 x 174				mm
DC input ⁽¹⁾	1 x MC4 pair	2 x MC4 pairs			
Weight with Connection Unit	10	11.4	11.9		kg
Noise	< 25				dB(A)
Cooling	Natural Convection				
Operating Temperature Range ⁽²⁾ ,	-40 to +60				°C
Ambient air pressure	minimum 860hPa - 1060hPa				
Protection Rating	IP65 - Outdoor and Indoor (Inverter with Connection Unit)				

(1) Connection of additional strings in parallel to a single input is allowed as long as the cumulative current does not exceed 45A.

(2) Full power up to at least 50°C. For power de-rating information refer to:

<https://www.solaredge.com/sites/default/files/se-temperature-derating-note.pdf>

Recommended OCPD size per grid:

Inverter	Maximum Output Current (A)	Minimum Fuse Rating (A)	Maximum fuse rating (A)
SE3680H	16	20	50
SE4000H	18.5	25	50
SE5000H	23	32	50
SE6000H	27.5	40	50

Default Trip Limits and Times According to IEEE1547

NOTE



The inverters are equipped with adjustable utility protective function set-points, and can be aggregated above 30kW on a single Point of Common Connection. The default settings are in compliance with IEEE1547. Utility authorization is required to change these set-points.

Voltage Range (% of Base Voltage)	Maximum Clearing Time (Sec)
V < 50%	0.16
50 % < V < 88%	2.00
110% < V < 120%	1.00
V > 120 %	0.16
Frequency Range (Hz)	Maximum Clearing Time (Sec)
> 60.5	0.16
< 59.3 (Hawaii – 57)	0.16

EV Charger and EV Charger Cable Specifications



NOTE

The EV Charger and EV Charger cable are ordered separately.

EV CHARGER		
Charging Mode	AC Mode 3 Connection to the SolarEdge monitoring platform is required for first EV charging	
Rated AC Power Output	7400	W
Nominal AC Output Voltage	230	Vac
Nominal AC Frequency	50 / 60	Hz
Maximum Continuous Output Current @230V	32	Aac
Residual Current Detector (AC)	30	mA rms
Residual Current Detector (DC)	6	mAdc
ADDITIONAL FEATURES		
EV Charger Status LEDs, Fault Indicator	Yes	
EV Charger Ground Connection Monitoring	Yes, continuous	
EV Charger Configuration	Via the monitoring app; Ethernet, Wi-Fi or ZigBee connection is required ⁽¹⁾	
EV Charger Unplugging Detection	Yes, current termination according to IEC 62196	
STANDARD COMPLIANCE		
Safety	IEC 61851, IEC 62752:2016	
EV Charger	IEC 62196	
INSTALLATION SPECIFICATIONS		
EV Charger Connector	IEC 62196 Type 1 /Type 2	
EV Charger Cable Length ⁽²⁾	7.6 (4.6 option)	m
EV Charger Cable Weight	5.7 (3.5 for 4.6m option)	kg

⁽¹⁾Cellular connection may be used; requires a SIM card with a 50MB data plan that should be purchased from a cellular provider; a SolarEdge data plan supports activation only

⁽²⁾EV Charger cable ordered separately.

EV Charger Cable Operating Temperature Range	-30 to +50	°C
Protection Rating (connected to EV or with dust cap)	IP54	

If you have technical queries concerning our products, please contact our support through the SolarEdge service portal: www.solaredge.com/service/support

Australia (+61)	1800 465 567
APAC (Asia Pacific)(+972)	073 240 3118
Belgium (+32)	0800 76633
Netherlands (+31)	0800 7105
China (+86)	21 6212 5536
DACH & Rest of Europe (+49)	089 454 59730
France (+33)	0806 700409
Italy (+39)	0422 053700
Japan (+81)	03 6262 1223
New Zealand (+64)	0800 144 875
US & Canada (+1)	510 498 3200
United Kingdom (+44)	0800 028 1183
Republic of Ireland (+353)	1 800 901 575
Greece (+49)	89 454 59730
Israel (+972)	073 240 3122
Middle East & Africa (+972)	073 240 3118
South Africa (+27)	0800 982 659
Turkey (+90)	216 706 1929
Worldwide (+972)	073 240 3118